



# QUARRY

the best choice for nature.



GIGACER®

# Index

## 01. INSPIRATION

European stone look

pag. 02

## 02. REASON WHY

The best choice for nature  
The most advanced technology for us

pag. 04

## 03. GALLERY

Residential & commercial spaces

pag. 10

## 04. PRODUCT GUIDE

Colours, formats and surfaces

pag. 36

## 05. TECHNICAL SECTION

Technical information

pag. 42

**Gigacer produce ceramica: lastre in gres porcellanato tecnico per l'architettura. La ceramica, a differenza di molti altri materiali è igienica, anallergica, non trattiene lo sporco nè i batteri. E' costituita da materiali naturali, senza plastiche o derivati del petrolio, è assolutamente inodore, non brucia e, in caso di incendio, non rilascia sostanze nocive. La ceramica viene incollata con collanti sicuri, che non rilasciano sostanze nell'atmosfera nel lungo periodo. Dura a lungo, si pulisce facilmente, resiste a detergenti chimici aggressivi e può essere utilizzata sia per ambienti interni che esterni, infatti non si deforma e non gela. La ceramica è una scelta bella e sicura.**

Gigacer manufactures ceramics: slabs of technical porcelain stoneware for architecture. Ceramic, unlike many other materials, is hygienic, hypoallergenic and it does not retain dirt or bacteria. Ceramic is made of natural materials, without plastics or petroleum derivatives. It is absolutely odourless, it does not burn and, in case of fire, it does not release harmful substances. Ceramic is glued with safe adhesives, which do not release substances into the atmosphere in the long term. Ceramic lasts for a long time, is easily cleaned, resistant to aggressive chemical detergents and it can be used both for internal and external environments, in fact it does not deform and does not freeze. Ceramic is a beautiful and safe choice.



# 01. INSPIRATION

**Quarry** reinterpreta in chiave tecnica la solida forza di **sei pietre tipicamente europee**.

La prima pietra ispiratrice è la **Quarzite Bianca**, da cui prende il nome e il colore. Diffusa nelle catene montuose delle Prealpi, **Arenaria** interseca vene bianche al colore grigio. **Gravel Stone** richiama la pietra del Cardoso, le cui cave sono ubicate in prossimità del paese toscano. **Lava Stone** arriva dal Belgio, con una nuance scura. La Spagna è l'origine di **Crema Marfil**, una pietra dal colore beige a sfondo uniforme. Infine **Golden Stone** si ispira alla pietra fossile tedesca Solnhofen ed è proposta nel tono caldo del materiale originale.

**Quarry** reinterprets the solid power of **six typically European stones** in a technical way.

The first stone inspiring us is **Quarzite Bianca** (white quartzite), the origin of its name and colour. Common in the Alpine foothills, **Arenaria** (sandstone) is grey in colour shot through with white veins. **Gravel Stone** brings to mind Cardoso stone with quarries near this Tuscan town. **Lava Stone** comes from Belgium and is dark. Spain is the origin of **Crema Marfil**, a homogeneous beige coloured stone. Lastly **Golden Stone** takes its inspiration from the Solnhofen German fossil stone and is offered in the warm hues of the original material.



## 02. REASON WHY

**Gigacer** ha dato vita, 12 anni fa, nel 2007, ad una filosofia di prodotto e ad un metodo di lavoro condiviso da tutti: il **rispetto per l'ambiente** è l'elemento principe del suo progetto.

Il processo produttivo di **Quarry** prevede la preparazione preliminare di un unico formato, grandi lastre in gres porcellanato multistrato 120x120 cm, che possono essere successivamente tagliate e modificate a freddo in molteplici altri formati mantenendo la massima garanzia di requisiti tecnici, qualitativi ed estetici, tutto nel rafforzamento del nostro concetto innovativo del **Made in Italy**.

In 2007, 12 years ago now, **Gigacer** breathed life into a product philosophy and working method shared by all: **respect for the environment** is the key to its design. **Quarry's** production process involves preliminary single format preparation consisting of great slabs of multi-layer porcelain stoneware measuring 120 x 120 cm which can subsequently be cut and modified cold into a multiplicity of other formats whilst maintaining maximum technical, quality and aesthetic requisite guarantees, all of which reinforce our innovative **Made in Italy** concept.



**Lo stabilimento è dislocato in un quartiere interamente progettato in biourbanistica (1)**  
Our plant is located on an interesting out of town site designed according to bio-planning principles

Lo stabilimento è dislocato in un quartiere interamente progettato in **biourbanistica** (1). Questa ubicazione è possibile grazie al rispetto di tutte le normative vigenti in materia ambientale.

**Gigacer** si impegna a **riciclare totalmente gli scarti** (2) di lavorazione e il **consumo di acqua è ridotto al minimo** grazie ad un impianto di depurazione che permette di riutilizzare completamente l'acqua impiegata per la levigatura e la rettifica. **Le emissioni dei camini sono largamente inferiori ai limiti prescritti dall'UE** (3) e i rumori sono contenuti grazie all'utilizzo di camini e ventilatori insonorizzati posti in zona protetta. Infine Gigacer ha studiato per tutti i prodotti un **packaging antinfortunistico** (4) con lastre in orizzontale, garantendo la sicurezza degli operatori sul cantiere e riducendo al minimo la quantità di carta e cartone da smaltire.

Our plant is located on an interesting out of town site designed according to **bio-planning principles** (1). This location is made possible by respect for all current environmental laws.

**Gigacer** has undertaken to **recycle all leftovers** (2) and **water consumption has been reduced to a minimum** thanks to a water treatment plant which enables 100% of the water used in polishing and rectification to be reused. **Air emissions are considerably below EU limits** (3) and noise is kept down with specially designed systems: chimney stacks and sound proofed ventilators located in protected areas. Lastly Gigacer has designed **accident prevention packaging** for all its products (4) with horizontal slabs guaranteeing worker safety on site and reducing volumes of paper and cardboard waste.

# Eco Friendly



**Riciclo totale degli scarti (2)**  
All leftovers recycling



**Le emissioni sono inferiori ai limiti prescritti dall'UE (3)**  
Air emissions are considerably below EU limits



**Packaging antinfortunistico (4)**  
Accident prevention packaging

# Highly Technical

**Quarry** è una collezione unica per resistenza, durabilità, sicurezza e rispetto per l'ambiente.

Osservando lo spessore delle lastre si può notare che la base, composta di gres porcellanato ottenuto anche con l'aggiunta del riciclo degli sfridi produttivi (stesso materiale), viene ricoperta da uno strato di materiale nobile, composto da gres porcellanato colorato in massa, argille, grani, che vengono depositati sulla superficie prima della pressatura.

Questo metodo di lavorazione, oltre a regalare al prodotto un aspetto visibilmente e concretamente materico, ottimizza l'uso dei materiali.

I materiali superficiali nobili si ottengono infatti utilizzando quelli che in natura sono elementi scarsi, come tutti gli ossidi coloranti.

La base invece si produce utilizzando feldspati non colorati ed argille, alcune fra le risorse più abbondanti sul nostro pianeta.

**Quarry** evita così l'utilizzo indiscriminato di elementi chimici inorganici di disponibilità limitata dove non sia strettamente necessario.

Le pietre di **Quarry** sono ottenute senza l'utilizzo di smalti e sono rese impermeabili dall'alta temperatura di cottura.

**Quarry** is a uniquely hardwearing, resilient, safe and environmentally friendly collection.

Close observation of the slabs shows that the base - made up of porcelain stoneware obtained partially by the addition of recycled offcuts of the same material - is coated with a layer of noble material made up of porcelain stoneware coloured en masse and clays and grains which are deposited onto the surface prior to pressing.

In addition to producing a visibly and concretely material product, this working method optimises material use.

The noble surface materials are, in fact, obtained by using naturally scarce elements like all the colouring oxides whilst the base is generated using uncoloured feldspar and clay, some of the most abundant resources on earth.

**Quarry** thus avoids indiscriminate use of scarce inorganic chemical elements except where strictly necessary.

**Quarry** stones are obtained without the use of enamels and made impermeable by high firing temperatures.



**Inalterabile nel tempo**  
Stability over time



**Facile da pulire**  
Easy to clean



**Riciclabile**  
Recyclable



**Resiste ai raggi UV**  
UV resistant



**Non si graffia**  
Scratchproof



**Non teme sbalzi termici**  
Resistant to thermal shock



**Non si macchia**  
Stainproof



**Resiste agli acidi**  
Acid-resistant



**Igienica**  
Hygienic

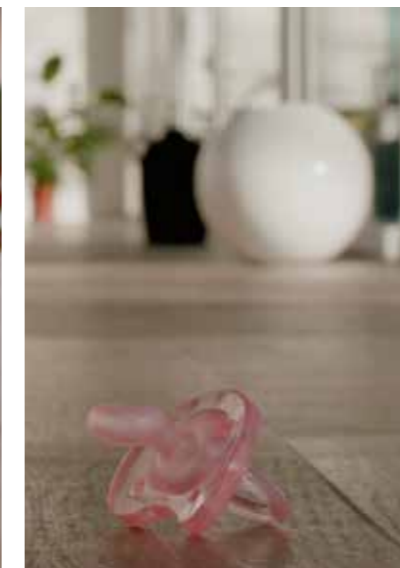

**Zero allergeni**  
Zero allergens



**Antiscivolo**  
Antislip



**Resistente al fuoco**  
Fire resistant



## 03. GALLERY

**Quarry** offre una grande versatilità: grazie ai **numerosi formati** e alle **due diverse superfici**, **mat R10 A+B** e **bocciardato antiscivolo R11 A+B+C**, è adatta agli **ambienti interni**, ma anche a quelli **esterni, residenziali e commerciali**.

**Quarry** offers great versatility: with its **numerous formats** and **two different surfaces**, **mat R10 A+B** and **bocciardato antislip R11 A+B+C**, it is suitable for both **indoor and outdoor, residential and business contexts**.

# Quarzite Bianca

Photo:

PAVIMENTO - FLOOR

Modulo/Module: 60x120 . 24"x48" Mat - 60x60 . 24"x24" Mat - 30x60 . 12"x24" Mat - 30x30 . 12"x12" Mat

RIVESTIMENTO - WALL

120x120 . 48"x48" Mat





# Quarzite Bianca

Photo:  
PAVIMENTO - FLOOR  
Modulo/Module: 60x120 . 24"x48" Mat - 60x60 . 24"x24" Mat - 30x60 . 12"x24" Mat - 30x30 . 12"x12" Mat  
RIVESTIMENTO - WALL  
120x120 . 48"x48" Mat



# Arenario

Photo:

PAVIMENTO - FLOOR

120x120 . 48"x48" Bocc. Antislip R11

Modulo/Module: 60x120 . 24"x48" Mat - 60x60 . 24"x24" Mat - 30x60 . 12"x24" Mat - 30x30 . 12"x12" Mat

RIVESTIMENTO - WALL

60x120 . 24"x48" Mat



# Arenaria

Photo:

PAVIMENTO - FLOOR

120x120 . 48"x48" Bocc. Antislip R11

Modulo/Module: 60x120 . 24"x48" Mat - 60x60 . 24"x24" Mat - 30x60 . 12"x24" Mat - 30x30 . 12"x12" Mat

RIVESTIMENTO - WALL

60x120 . 24"x48" Mat



# Gravel Stone

Photo:  
PAVIMENTO - FLOOR  
120x120 . 48"x48" Mat - 60x120 . 24"x48" Mat  
RIVESTIMENTO - WALL  
120x120 . 48"x48" Mat



# Gravel Stone

Photo:  
PAVIMENTO - FLOOR  
120x120 . 48"x48" Mat - 60x120 . 24"x48" Mat  
RIVESTIMENTO - WALL  
120x120 . 48"x48" Mat





## Lava Stone

Photo:  
PAVIMENTO - FLOOR  
Modulo/Module: 60x120 . 24"x48" Mat - 60x60 . 24"x24" Mat - 30x60 . 12"x24" Mat - 30x30 . 12"x12" Mat  
RIVESTIMENTO - WALL  
120x120 . 48"x48" Mat

# Lava Stone

Photo:  
PAVIMENTO - FLOOR  
Modulo/Module: 60x120 . 24"x48" Mat - 60x60 . 24"x24" Mat - 30x60 . 12"x24" Mat - 30x30 . 12"x12" Mat  
RIVESTIMENTO - WALL  
120x120 . 48"x48" Mat

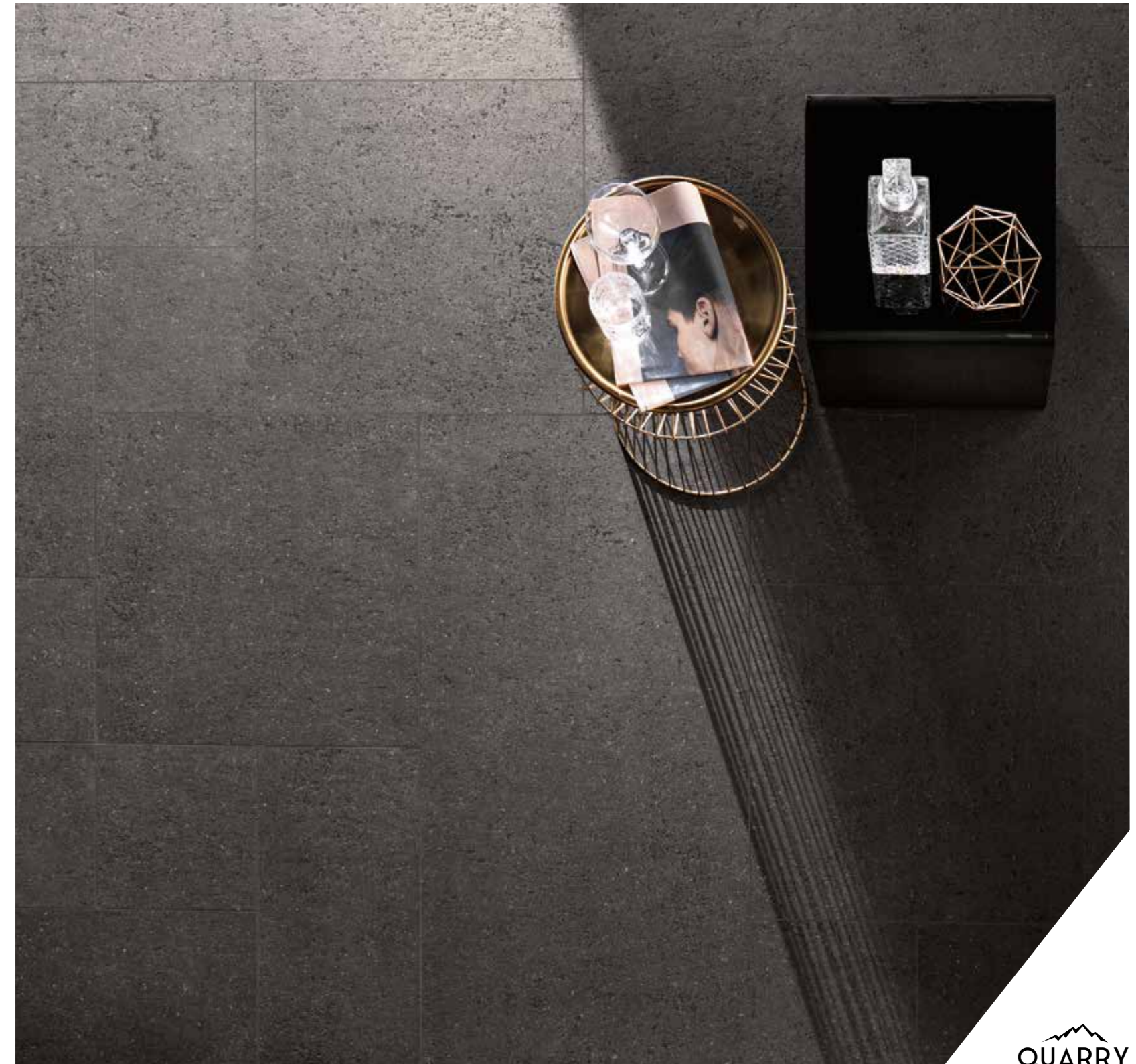



## Crema Marfil

Photo:

PAVIMENTO - FLOOR

Modulo/Module: 60x120 . 24"x48" Mat - 60x60 . 24"x24" Mat - 30x60 . 12"x24" Mat - 30x30 . 12"x12" Mat

RIVESTIMENTO - WALL

120x120 . 48"x48" Mat



# Crema Marfil

Photo:

PAVIMENTO - FLOOR

Modulo/Module: 60x120 . 24"x48" Mat - 60x60 . 24"x24" Mat - 30x60 . 12"x24" Mat - 30x30 . 12"x12" Mat

RIVESTIMENTO - WALL

120x120 . 48"x48" Mat

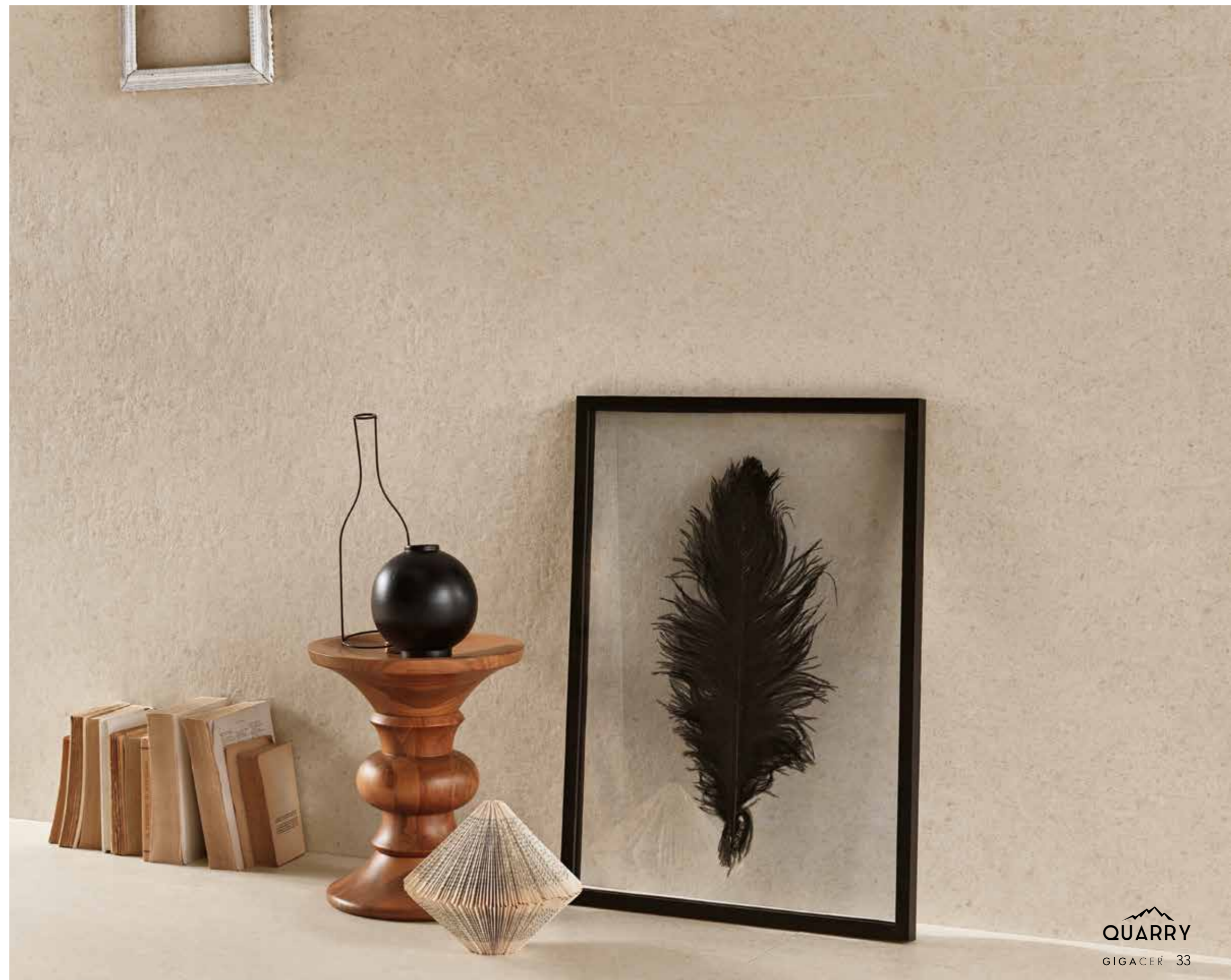



## Golden Stone

Photo:

PAVIMENTO - FLOOR

Modulo/Module: **60x120** . 24"x48" Bocc. Antislip R11 - **60x60** . 24"x24" Bocc. Antislip R11

**30x60** . 12"x24" Bocc. Antislip R11 - **30x30** . 12"x12" Bocc. Antislip R11

RIVESTIMENTO - WALL

**120x120** . 48"x48" Mat

# Golden Stone

Photo:

PAVIMENTO - FLOOR

Modulo/Module: 60x120 . 24"x48" Bocc. Antislip R11 - 60x60 . 24"x24" Bocc. Antislip R11

30x60 . 12"x24" Bocc. Antislip R11 - 30x30 . 12"x12" Bocc. Antislip R11

RIVESTIMENTO - WALL

120x120 . 48"x48" Mat



## 04. PRODUCT GUIDE

**Quarry:** una gamma composta da **sei colori, cinque formati, due finiture e due spessori** per soddisfare le esigenze di ogni progettista. Una palette cromatica che spazia dal bianco al nero, attraversando toni caldi e freddi, come il crema e il grigio. La combinazione delle due superfici garantisce **continuità cromatica** tra interno ed esterno, disegnando ambienti ineguagliabili.

**Quarry:** a range made up of **six colours, five formats, two finishings and two thicknesses** to satisfy all design demands. A colour palette ranging from white to black via warm and cold tones such as cream and grey. Combining the two surfaces guarantees **colour continuity** between outdoors and indoors, making for superlative spaces.

**Lastre di gres porcellanato multistrato**  
Multilayer porcelain slabs



**120x120 . 48"x48" - 60x120 . 24"x48" - 60x60 . 24"x24" - 30x60 . 12"x24" - 30x30 . 12"x12" / Spessore . Thickness 12 mm**  
**120x120 . 48"x48" - 60x120 . 24"x48" - 60x60 . 24"x24" / Spessore . Thickness 24 mm**



Quarzite Bianca



Arenaria



Gravel Stone



Lava Stone

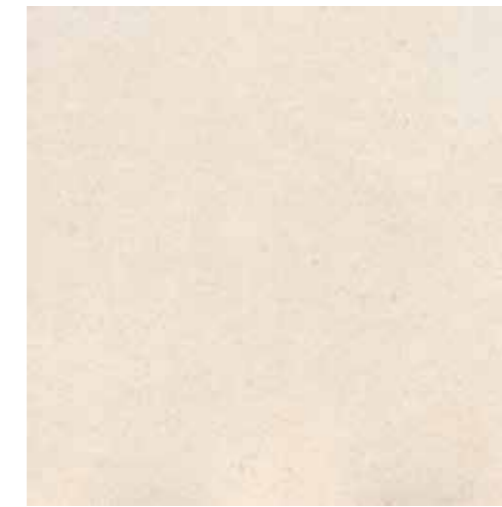

Crema Marfil



Golden Stone

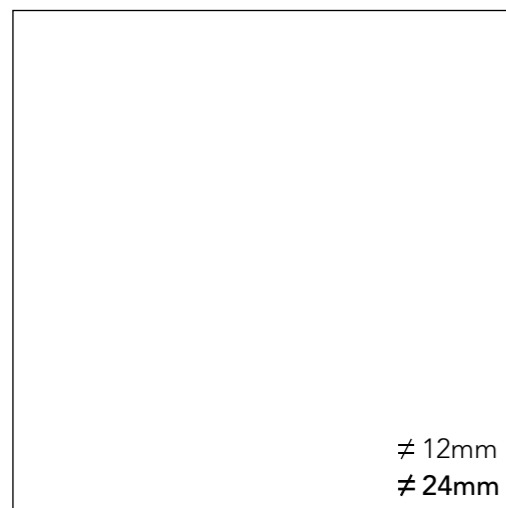

**120x120**  
48"x48"

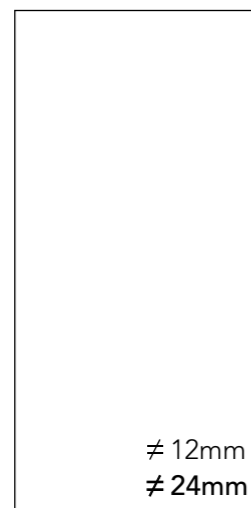

**60x120**  
24"x48"

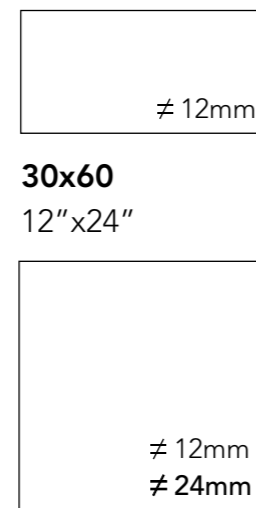

**60x60**  
24"x24"

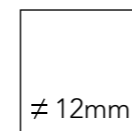

**30x30**  
12"x12"



**30x30**  
12"x12"



**30x30**  
12"x12"



**Modulo**  
Module

**2,70 mq**  
2,70 Sqm



**\*\*Mosaico Mix: Mat + Bocciardato Antiscivolo R11.** Mosaico Mix: Mat + Bocciardato Antislip R11.  
**\*\*\* Disponibile solo in superficie Mat.** Available only in Mat surface.

**Ogni modulo, composto da 2 pezzi di 60x120, 2 pezzi di 60x60, 2 pezzi di 30x60 e 2 pezzi di 30x30, è contenuto in un'unica scatola (pag. 45).** Each module, that is composed of 2 pieces of 60x120, 2 pieces of 60x60, 2 pieces of 30x60 and 2 pieces of 30x30, is packed in a single box (page 45).

**Battiscopa 60 . #12mm**  
Skirting 60 . #12mm

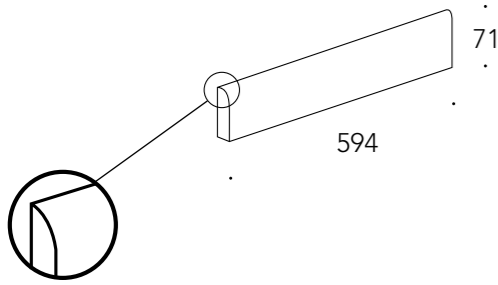

**Gradoni costa retta**  
Costa retta steptreads

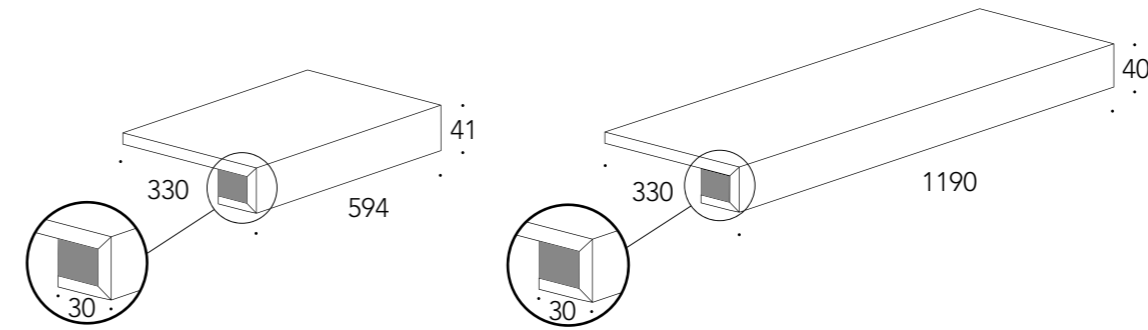

**Gradino Step a 5 scanalature**  
Step-tread (5 engravings)

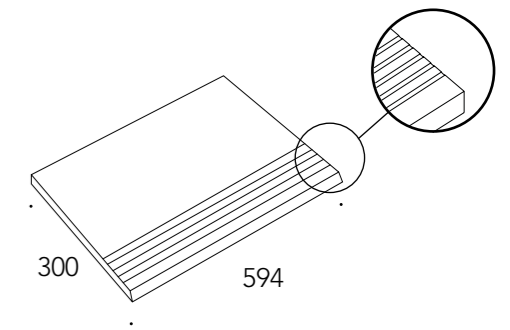

**La parte superiore del battiscopa 12mm viene arrotondata e smaltata a freddo.**  
The top of the 12mm thickness skirting pieces is cold glazed.

Modifiche su richiesta / Changes on request

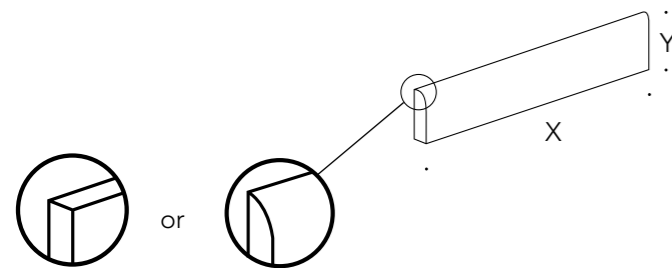

**È possibile richiedere la quotazione per le seguenti modifiche: 1- top squadrato invece che arrotondato . 2- top non smaltato (sarà visibile il multilayer) . 3- misure non standard: indicare misura X e Y in mm.**  
It is possible to request the quotation for the following changes: 1- squared top edge, instead of rounded . 2- unglazed top edge (the multilayer will be visible) . 3- bespoke sizes: please indicate X and Y in mm.

Modifiche su richiesta / Changes on request

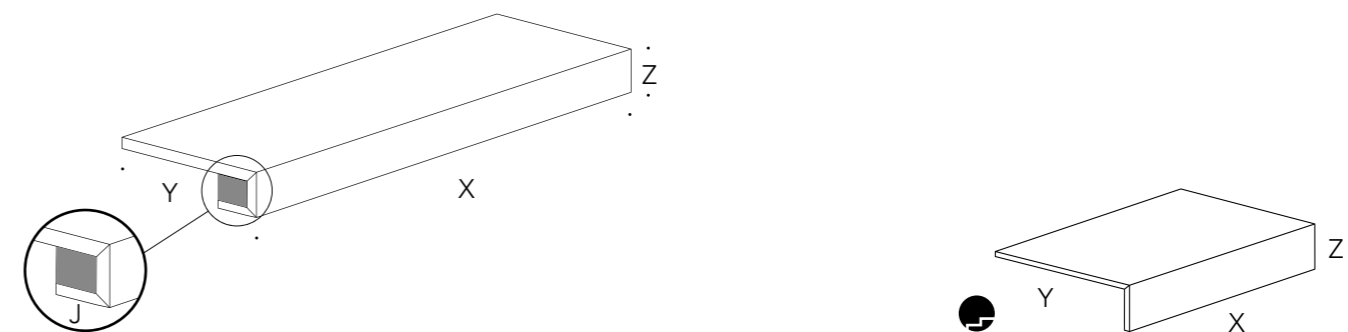

**Le misure X, Y, Z e J sono modificabili a piacimento. Misura minima (Z) 30mm, massima 1200 per X e Y. È possibile richiedere il gradone con chiusura su un lato o su entrambi, nel caso la scala sia aperta. Il pezzo può essere realizzato anche a vela (●) senza rientranza. È necessario indicare tutte le misure richieste (X, Y, Z).**  
It is possible to request bespoke sizes on X, Y, Z and J. Minimum size 30mm (Z), maximum 1200 for X and Y. It is possible to ask for one or both sides closed, if the staircase is open. The piece can be made without nose, only at 90° (●). All sizes must be specified (X, Y, Z and J).

# 05. TECHNICAL SECTION

<b>Consigli per la posa</b> Laying suggestions	pag. 44
<b>24mm Pavimenti sopraelevati</b> 24mm Raised floors	pag. 46
<b>Gigacer Service</b> Gigacer Service	pag. 48
<b>Imballi</b> Packaging	pag. 49
<b>Note tecniche e certificazioni</b> Technical notes and certifications	pag. 50

## DESTINAZIONI D'USO . INTENDED USE CLASSIFICATION

	Posa a terra in nuove costruzioni su massetto	Posa a terra su pavimenti esistenti, in ceramica o pietra naturale, o su massetto in costruzioni in stato di ristrutturazione	Rivestimenti muri	Ambienti pubblici interni a medio traffico	Ambienti pubblici interni ad alto traffico	Ambienti esterni	Pavimenti sopraelevati con struttura flottante o posa su supporti in PVC
	Floor tiling on screed in new buildings	Floor tiling on screed or on existing floor (in ceramic or natural stone) in buildings under renovation	Wall covering	Indoor public places subject to medium pedestrian traffic	Indoor public places subject to heavy pedestrian traffic	Outdoor places	Raised floor with floating structure or PVC supports
12 mm multilayer	++	+	+	++	++	+	+
24 mm	-	-	-	-	++	++	++
++ <b>Consigliato</b> . Recommended + <b>Appropriato</b> . Suitable				- <b>Non consigliato</b> . Not recommended -- <b>Non appropriato</b> . Not suitable			

## SUGGERIMENTO DI POSA . LAYING SUGGESTION

Gigacer sceglie per la collezione Quarry un modulo composto da due 60x120, due 60x60, due 30x60 e due 30x30.

La posa modulare è estremamente facilitata dall'imballo: ogni modulo è contenuto in un'unica scatola per semplificare la logistica in cantiere ed agevolare l'opera del posatore.

For its Quarry collection Gigacer has chosen modules made up of two 60x120, two 60x60, two 30x60 and two 30x30 slabs.

Modular laying is greatly facilitated by packaging: each module is packaged in a single box to simplify building site logistics and facilitate installation.

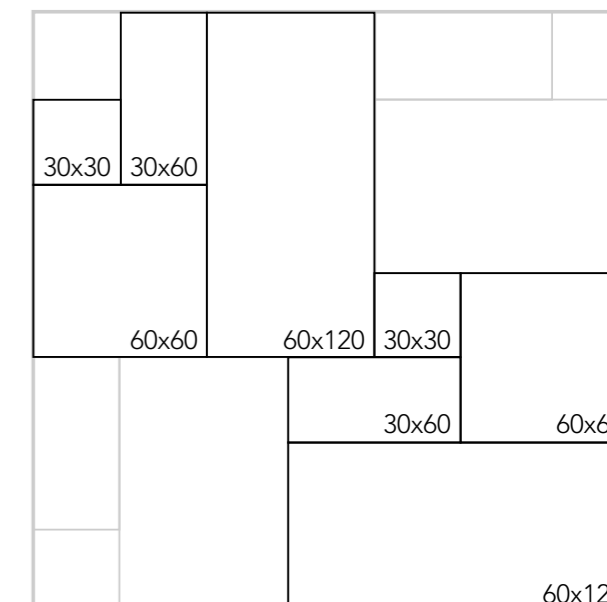

## CALIBRI . CALIBERS

Le nostre lastre sono sempre rettificate e hanno dimensioni finali in millimetri come da tabella.

Il calibro standard è lo 09 e i formati dello stesso calibro multipli tra loro sono modulari con 2mm di fuga.

Our slabs are always rectified and the table below indicates their final size in millimetres.

Our standard caliber is 09 and all sizes with the same caliber, when multiples, are modular with 2mm joint spacing.

Formato nominale (cm) Nominal size (cm)	Formato rettificato (mm) Rectified size (mm)	Calibro Caliber
120x120	1190x1190	09
60x120	594x1190	09
60x60	594x594	09
30x60	296x594	09
30x30	296x296	09

## MODULARITÀ . MODULARITY

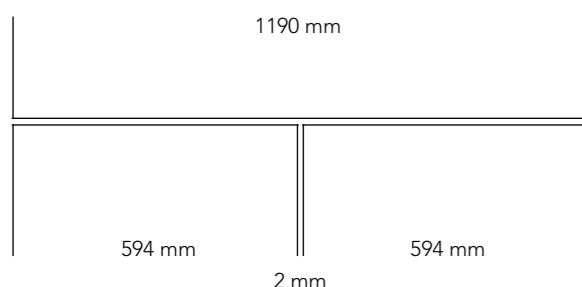

## INDICE DI STONALIZZAZIONE . SHADE VARIATION INDEX

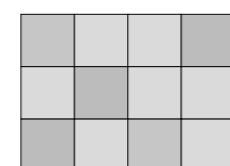

V2 - MODERATE

Prodotto con leggera variazione cromatica.  
Product with light chromatic variation.



## Crema Marfil

Modulo/Module: 60x120 . 24"x48" Mat - 60x60 . 24"x24" Mat - 30x60 . 12"x24" Mat - 30x30 . 12"x12" Mat



# 24mm pavimenti sopraelevati

## 24mm raised floors

La resistenza di 2 lastre di 12mm di spessore, incollate assieme con colla speciale garantisce un modulo di rottura di 18.140 kgf.  $\neq$ 24mm è resistente al gelo, ha un altissimo carico di rottura, è resistente ai sali, facile da pulire anche utilizzando idropulitrici, resistente agli attacchi di muffe, funghi, muschi e trattamenti al verderame. È rimovibile, riutilizzabile, antiscivolo, resistente al fuoco e facile da installare.  $\neq$ 24mm non cambia col tempo e resiste a tutte le condizioni climatiche, caratteristiche fondamentali per un pavimento esterno. La posa può essere fatta utilizzando diverse tecniche, secondo il tipo di superficie da ricoprire. Le lastre possono essere installate a secco direttamente su ghiaia, sabbia o altri substrati, possono essere stese su supporti sopraelevati (es. Eterno Ivica Pedestal) o incollate. L'installazione sopraelevata può essere effettuata con una struttura portante di moduli in polipropilene, che possono essere fissi, regolabili e autolivellanti. Hanno una altezza minima di 37,5 mm e massima di 230 mm. L'installazione sopraelevata consente una facile ispezione di cavi o condutture senza dover rompere il pavimento.  $\neq$ 24mm pavimento sopraelevato è la migliore soluzione per luoghi residenziali o commerciali come balconi, vialetti, ecc. dal momento che protegge la superficie sottostante e consente ogni tipo di intervento tecnico. Consigliamo una fuga di 4mm per lo scolo dell'acqua.

The strength of 2 12mm thick tiles glued together with a special glue grants a modulus of rupture of 18.140 Kgf.  $\neq$ 24mm is frostresistant, has a very high breakage load, it is resistant to salts, easy to clean also using pressure washers, resistant to the attack of mould, moss and verdigris treatments, removable, reusable, anti-slip, fire-resistant and very easy to install.  $\neq$ 24mm does not change and lasts over time in any climatic conditions, characteristics that are a must for outdoor floor coverings. Installation can be done using different techniques, according to the kind of surface. The porcelain stoneware slabs can be laid using a dry installation system, directly onto gravel or sand substrates as well as with raised installation (i.E. Eterno Ivica Pedestals) or glued. Raised installation is made with a support structure made of polypropylene, prefabricated, load-bearing modules, which can be fix, adjustable and self levelling. They have a minimum height of 37,5mm and a Maximum height of 230mm. Raised installation allows for easy inspection of underlying cabling and circuits without the need for burdensome work.  $\neq$ 24mm raised floor is the best solution for residential and commercial destinations such as balconies, paths, access floors, etc., Protecting the under-space and easily allowing any kind of technical intervention. A 4 mm joint is requested for water drainage.

### I VANTAGGI DEL 24mm . THE ADVANTAGES OF 24mm

- Possibilità di avere un prodotto con lo stesso tono e superficie posato nelle aree interne ed esterne
- Grande formato 120x120 in 24mm di spessore
- Possibilità di avere un pavimento antiscivolo all'esterno con posa facilitata
- Drenaggio efficace
- Posa a secco
- Durata e resistenza
- Pulibilità
- Ingelività

Lo stucco del bordo del 24mm è colorato in tinta con il fondo scelto.

#### Esempi di utilizzo del 24mm:

pavimento sopraelevati / terrazzi all'aperto / terrazze chiuse / vialetti esterni / piscine / giardini / piatti doccia.

- Possibility to have a product with the same tone and surface for indoor and the outdoor spaces
- Big format 120x120 24 mm thickness
- Possibility to have an antislip material for the outdoor with easy lay
- Efficient drainage
- Dry laying
- Endurance and strength
- Cleanability
- Frost resistance

The grout in the 24mm thickness has the same colour of the tiles.

24mm intended uses (some examples): raised access floors / open terraces / closed terraces / walkways / swimming pools / gardens / shower trays.

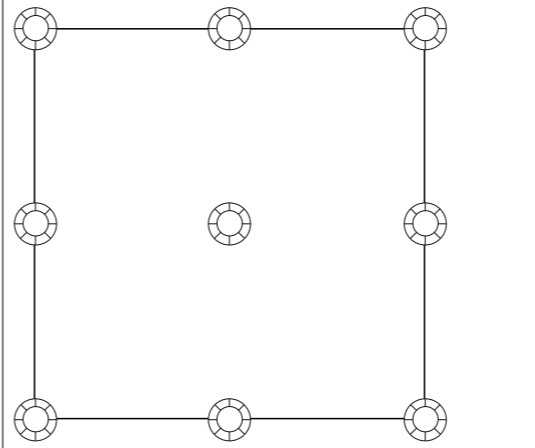
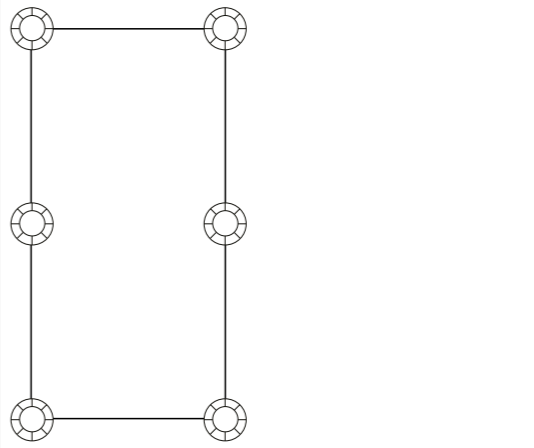
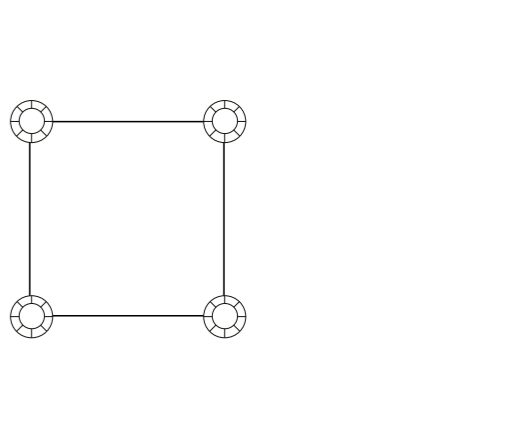

### PIEDINI IN POLIPROPILENE . POLIPROPYLENE SUPPORTS

120x120 . 48"x48" 9 pz/lastra 9 pcs/slab	60x120 . 24"x48" 6 pz/lastra 6 pcs/slab	60x60 . 24"x24" 4 pz/lastra 4 pcs/slab
		
80 kg	40 kg	20 kg

**Gigacer Service è il servizio di lavorazioni su misura offerto da Gigacer su tutti i suoi prodotti. Consente di tagliare, forare, lucidare e in generale adattare le lastre al singolo progetto, seguendo le indicazioni di uno specifico disegno del cliente.**

**In questo modo le lastre ceramiche possono essere utilizzate sia per realizzare elementi d'arredo, sia per personalizzare o adeguare al progetto le dimensioni di lastre per pavimento o rivestimento.**

**Il pavimento o il rivestimento potrà così essere abbinato o addirittura identico al top cucina, ai gradini della scala, al top bagno o anche allo stesso lavabo, in una infinita possibilità di forme e dimensioni.**

**Il pezzo unico viene realizzato anche seguendo le indicazioni e il disegno tecnico del progettista.**

Gigacer Service is the firm's made to measure working service offered on all products.

It enables slabs to be cut, perforated, polished and generally adapted to the individual project in line with the requisites of a specific client design.

In this way the ceramic slabs can be used both to create decor elements and to personalise or adjust slab dimensions to flooring or decor designs.

In this way the floor can be matched with, or even identical to, the kitchen worktop, flights of steps, the bathroom worktop and even the basin in an infinity of possible forms and dimensions. Each single piece can be made in accordance with designers' instructions and technical drawings.

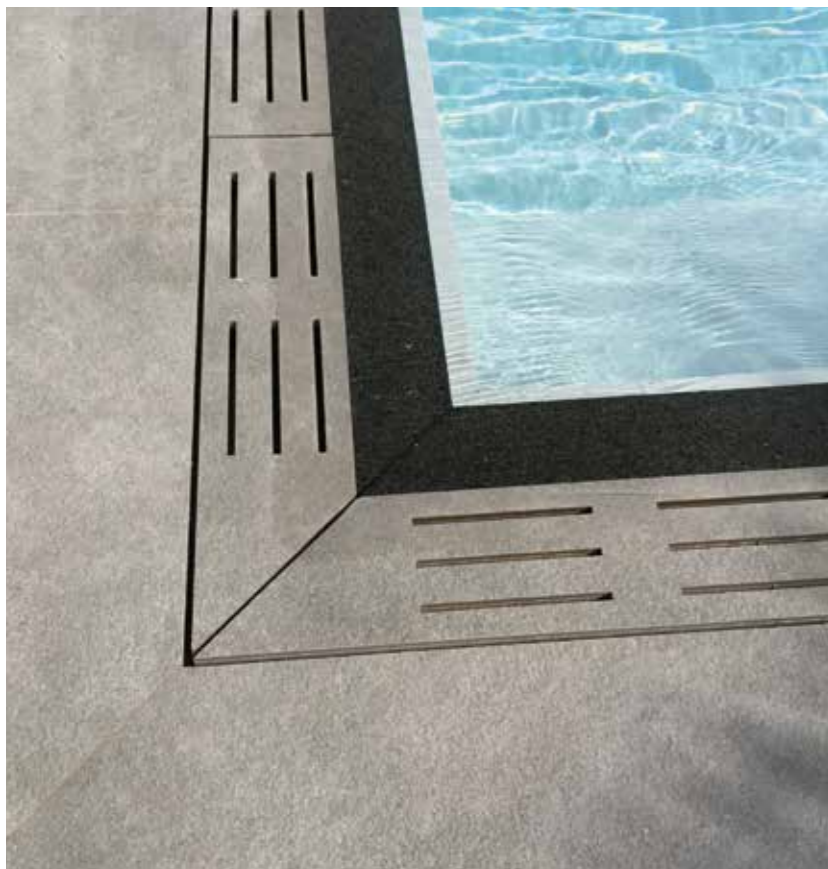

# gigacer service e imballi

## gigacer service and packaging

### Imballi . Packaging

Formato nominale Nominal size	Formato rettificato Rectified size	Pallet (cm) Pallet (cm)	Pz/Collo Pcs/Box	Mq/Collo Sqm/Box	Kg/Collo Kg/Box	Colli/Plt Boxes/plt	Mq/Plt Sqm/Plt	Kg/Plt Kg/Plt
<b>24mm</b>								
<b>120x120 cm . 48"x48"</b>	1190x1190 mm	120x120	1	1,44	82,00	12	17,28	1010
<b>60x120 cm . 24"x48"</b>	594x1190 mm	120x120	1	0,72	41,00	24	17,28	1010
<b>60x60 cm . 24"x24"</b>	594x594 mm	120x120	1	0,36	20,50	48	17,28	1010
<b>12mm</b>								
<b>120x120 cm . 48"x48"</b>	1190x1190 mm	120x120	1	1,44	40,30	36	51,84	1482
<b>60x120 cm . 24"x48"</b>	594x1190 mm	120x120	2	1,44	40,30	36	51,84	1482
<b>60x60 cm . 24"x24"</b>	594x594 mm	120x120	2	0,72	20,10	72	51,84	1482
<b>30x60 cm . 12"x24"</b>	296x594 mm	120x120	2	0,36	10,00	144	51,84	1482
<b>30x30 cm . 12"x12"</b>	296x296 mm	120x120	2	0,18	5,00	288	51,84	1482
<b>Modulo . Module</b>	-	80x120 euro	*	2,70	75,00	6	16,20	452
<b>Mosaico Mix . Mosaic Mix 30x30 cm . 12"x12"</b>	296x296 mm	80x120 euro	8	-	20,20	-	-	-
<b>Mosaico Trail . Mosaic Trail 30x30 cm . 12"x12"</b>	296x296 mm	80x120 euro	8	-	20,20	-	-	-
<b>Battiscopa . Skirting 60x7,1 . 24"x3"</b>	594x71 mm	-	10	-	16,00	-	-	-
<b>Gradino step . Step-tread 60x30 . 24"x12"</b>	594x296 mm	-	4	-	20,20	-	-	-
<b>Gradino . Step costa retta 60 60x33x4 . 24"x13"x1 1/2"</b>	594x330x40 mm	-	4	-	26,00	-	-	-
<b>Gradino . Step costa retta 120 120x33x4 . 48"x13"x1 1/2"</b>	1190x330x40 mm	-	2	-	26,00	-	-	-

<b>SU RICHIESTA: imballo per container. ON REQUEST: packaging for container - 12mm</b>								
<b>Modulo . Module</b>	-	80x120 euro	*	2,70	75,00	21	56,70	1575















**\* Dettaglio imballo per collo . Detail of pcs/box:**

- 2 pz/pcs 60x120 cm . 24"x48" - 2 pz/pcs 60x60 cm . 24"x24" - 2 pz/pcs 30x60 cm . 12"x24" - 2 pz/pcs 30x30 cm . 12"x12"

**Gigacer non si assume nessuna responsabilità per danni causati al materiale da errate manovre di carico o scarico, da movimentazioni non autorizzate o da eventi accidentali di qualsiasi tipo.**

Gigacer assumes no responsibility for damages caused by incorrect handling of the material loading or unloading, unauthorized handling or accidents of any kind.

### CARATTERISTICHE TECNICHE . TECHNICAL SPECIFICATIONS

LASTRE DI GRES PORCELLANATO MULTISTRATO . MULTILAYER PORCELAIN SLABS . ISO 13006 - G - BIa UGL (E ≤ 0,5%) UNI EN 14411 - G -					
	CARATTERISTICHE TECNICHE TECHNICAL SPECIFICATIONS	NORMA ISO STANDARD STANDARD ISO NORM	SPESSORE THICKNESS	VALORI PRESCRITTI DALLE NORME INTERNATIONAL STANDARDS	VALORE MEDIO GIGACER AVERAGE GIGACER VALUE
	CARATTERISTICHE DIMENSIONALI DIMENSIONAL CHARACTERISTICS	ISO 10545-2	-	S > 410	
	LATI SIDES		-	± 0,6%	± 0,2%
	SPESSORE THICKNESS		-	± 5%	± 3%
	RETTILINEITÀ DEGLI SPIGOLI STRAIGHTNESS OF EDGES		-	± 0,5%	± 0,2%
	ORTOGONALITÀ RECTANGULARITY		-	± 0,6%	± 0,2%
	PLANARITÀ SURFACE FLATNESS	-	± 0,5%	± 0,2%	
	ASSORBIMENTO D'ACQUA WATER ABSORPTION	ISO 10545-3	-	≤ 0,5%	≤ 0,1%
	RESISTENZA ALLA FLESSIONE BENDING STRENGTH	ISO 10545-4	≠ 12 mm	≥ 35N/mm <sup>2</sup>	≥ 40 N/mm <sup>2</sup>
	MODULO DI ROTTURA MODULUS OF RUPTURE	ISO 10545-4	≠ 12 mm	> 1.300N (sp. ≥ 7,5mm)	≥ 4000 N
			≠ 24 mm	> 1.300N (sp. ≥ 7,5mm)	18,14 kN (=18.140 kgF)
	RESISTENZA ALL'ABRASIONE PROFONDA RESISTANCE TO DEEP ABRASION	ISO 10545-6	-	≤ 175mm <sup>3</sup>	≤ 145mm <sup>3</sup>
	COEFFICIENTE DI DILATAZIONE TERMICA LINEARE COEFFICIENT OF LINEAR THERMAL EXPANSION	ISO 10545-8	-	≤ 9X10 <sup>6</sup> °c 1	≤ 7X10 <sup>6</sup> °c 1
	RESISTENZA AGLI SBALZI TERMICI RESISTANCE TO THERMAL SHOCKS	-	-	METODO DISPONIBILE AVAILABLE METHOD	RESISTE RESISTANT
	RESISTENZA AL GELO FROST RESISTANCE	ISO 10545-12	-	METODO DISPONIBILE AVAILABLE METHOD	RESISTE RESISTANT
	RESISTENZA ALL'ATTACCO CHIMICO RESISTANCE TO CHEMICAL ATTACKS	ISO 10545-13	-	min. UB	RESISTE RESISTANT
	RESISTENZA ALLE MACCHIE STAIN RESISTANCE	ISO 10545-14	-	METODO DISPONIBILE AVAILABLE METHOD	RESISTE RESISTANT

LASTRE DI GRES PORCELLANATO MULTISTRATO . MULTILAYER PORCELAIN SLABS . ISO 13006 - G - BIa UGL (E ≤ 0,5%) UNI EN 14411 - G -									
		SUPERFICIE SURFACES	SPESSORE THICKNESS	DIN 51130	DIN 51097	BCR	BRITISH PENDULUM BS7976	R9729 UPI/EMPA	DCOF (SECTION 9.6 ANSI A 137.1.2012)
	COEFFICIENTE D'ATTRITO COEFFICIENT OF FRICTION	MAT	≠12mm ≠24mm	R10	A+B	> 0,40	> 36 WET	GS2/GB1	> 0,42 wet
		BOCCIARDATO ANTISLIP	≠12mm ≠24mm	R11	A + B + C	> 0,40	> 36 WET	GS2/GB1	> 0,42 wet

### CERTIFICAZIONI . CERTIFICATIONS

Gigacer ha conseguito le certificazioni di processo ISO 9001:2015 e ISO 14001:2015. Gigacer ha conseguito le certificazioni UNI EN 14411:2012. La qualità dei prodotti Gigacer viene controllata costantemente tramite test effettuati dai principali laboratori ed enti di certificazione internazionali.

Gigacer has achieved the process certifications ISO 9001:2015 e ISO 14001:2015. Gigacer has achieved the process certifications UNI EN 14411:2012. The quality of Gigacer products is constantly monitored with tests made by the main international certification laboratories.



Tutte le informazioni relative a destinazione d'uso, posa, taglio, fori, giunti, pulizia e manutenzione sono disponibili sul nostro sito web [www.gigacer.it](http://www.gigacer.it).

All the information concerning use, installation, cutting, holes, joints, cleaning and maintenance are available on our website [www.gigacer.it](http://www.gigacer.it).

**Publicato da** | Published by  
**GIGACER** spa

Dicembre 2019

**Quanto contenuto nel catalogo è puramente indicativo riguardo a colori e decorazioni.**  
Real colours and decorations might slightly differ those depicted in this catalogue.



Gigacer S.p.A.  
Via Caltagirone 72 · 48018 Faenza (RA) IT

t. +39 0546 637111  
f. +39 0546 637127

info@gigacer.it  
www.gigacer.it

